

E FIGHET

Air Conditioner Cooling & Heating
Climatizzatore Caldo e Freddo



Air diffuser panel
Pannelli per distribuzione aria

Possibility of using several diameter couplings
for various diameter of duct.

Diameter 40-45-50-55-60 mm.

Related accessories: Section M - pag. 154

Possibilità di utilizzare giunti diversi
a seconda del diametro del condotto.

Diametro 40-45-50-55-60 mm.

Accessori collegati: Sezione M - pag. 154



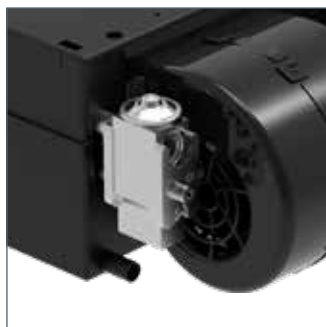
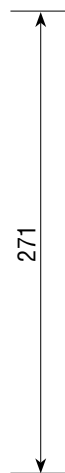
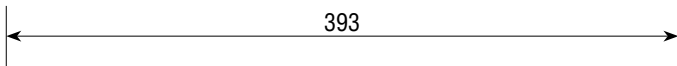
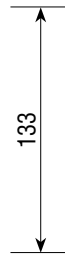

Flange expansion valve

Valvola espansione flangiata





Heater fittings 16 mm

Raccordi riscaldamento 16 mm

E FIGHET Air Conditioner Cooling & Heating / Climatizzatore Caldo e Freddo

HVAC Cooling & Heating / Freddo e Caldo

	Part. Codice	Voltage Voltaggio	Ampere Amperaggio	Cooling Freddo	Heater Caldo	Air m ³ /h Aria m ³ /h	Weight Peso	Case Rivestimento
	AOCF00154-00	12 V	14 A	5.5 kW	4.5 kW	600	4 kg	Plastic ABS
	AOCF00155-00	24 V	7 A	5.5 kW	4.5 kW	600	4 kg	Plastic ABS
	AOFF00154-00	12 V	14 A	5.5 kW	-	600	3.8 kg	Plastic ABS
	AOFF00155-00	24 V	7 A	5.5 kW	-	600	3.8 kg	Plastic ABS
	AOCC00154-00	12 V	14 A	-	4.5 kW	600	3.7 kg	Plastic ABS
	AOCC00155-00	24 V	7 A	-	4.5 kW	600	3.7 kg	Plastic ABS