

## GEVAL DO

Air Conditioner Cooling & Heating  
Climatizzatore Caldo e Freddo



Air diffuser panel  
Pannelli per distribuzione aria

Possibility of using several diameter couplings  
for various diameter of duct.

Diameter 40-45-50-55-60 mm.

Related accessories: Section M - pag. 153

Possibilità di utilizzare giunti diversi  
a seconda del diametro del condotto.

Diametro 40-45-50-55-60 mm.

Accessori collegati: Sezione M - pag. 153



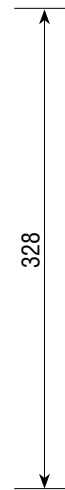
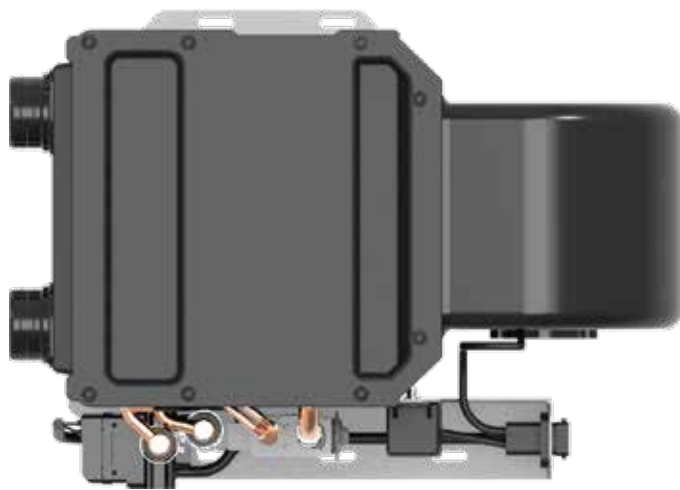
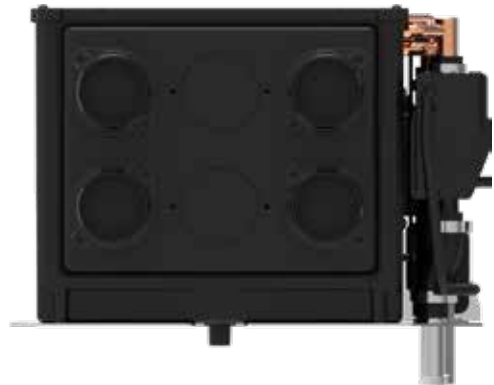
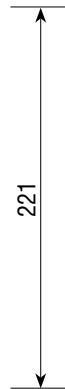
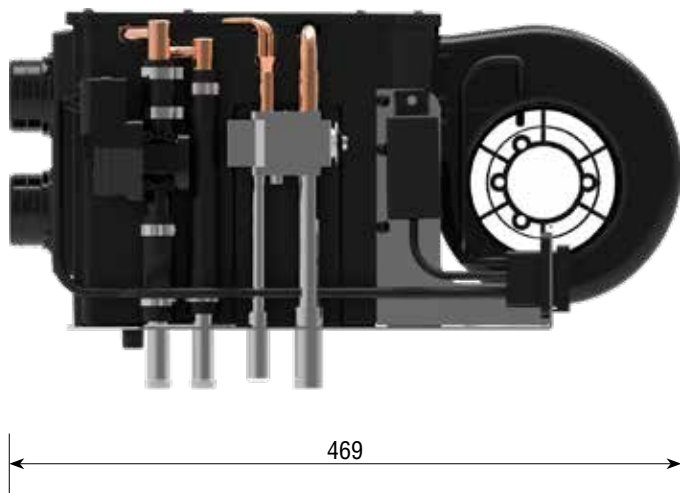

Thread size: / Filetto:  
5/8" and 7/8"





Heater fittings 16 mm

Raccordi riscaldamento  
16 mm

**GEVAL DO** Air Conditioner Cooling & Heating / Climatizzatore Caldo e Freddo

**HVAC**  Cooling & Heating / Freddo e Caldo

	Part. Codice	Voltage Voltaggio	Ampere Amperaggio	Cooling Freddo	Heater Caldo	Air m <sup>3</sup> /h Aria m <sup>3</sup> /h	Weight Peso	Case Rivestimento
	A0CF52ES	12 V	18 A	8 kW	7 kW	970	8 kg	Plastic injection
	A0CF53ES	24 V	9 A	8 kW	7 kW	970	8 kg	Plastic injection
	A0FF52ES	12 V	18 A	8 kW	-	970	8 kg	Plastic injection
	A0FF53ES	24 V	9 A	8 kW	-	970	8 kg	Plastic injection