



**Serpentine Condenser
Condensatore a serpentina**

Part. Codice	kcal/h	Fin Pitch Passo alette
B01200001	7000	2.1 mm

A - 3/4"-16 UNF / 2A O-Ring

B - 5/8"-18 UNF / 2A O-Ring

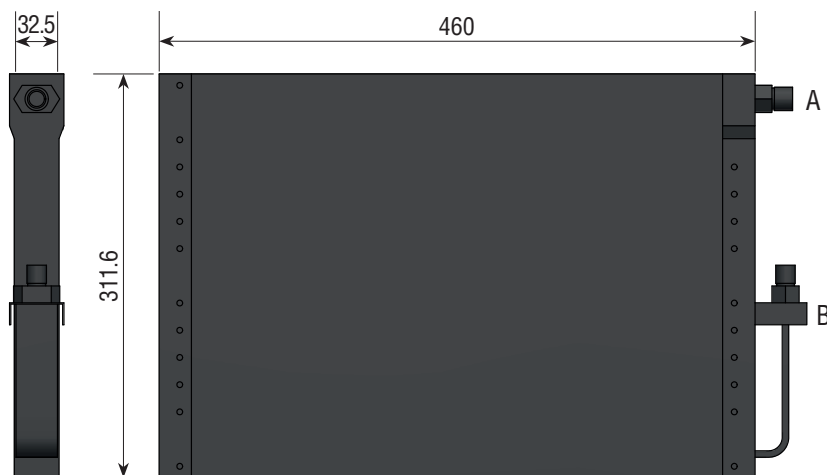

**Serpentine Condenser
Condensatore a serpentina**

Part. Codice	kcal/h	Fin Pitch Passo alette
B01200002	7000	2.1 mm

A - 3/4"-16 UNF / 2A O-Ring

B - 5/8"-18 UNF / 2A O-Ring

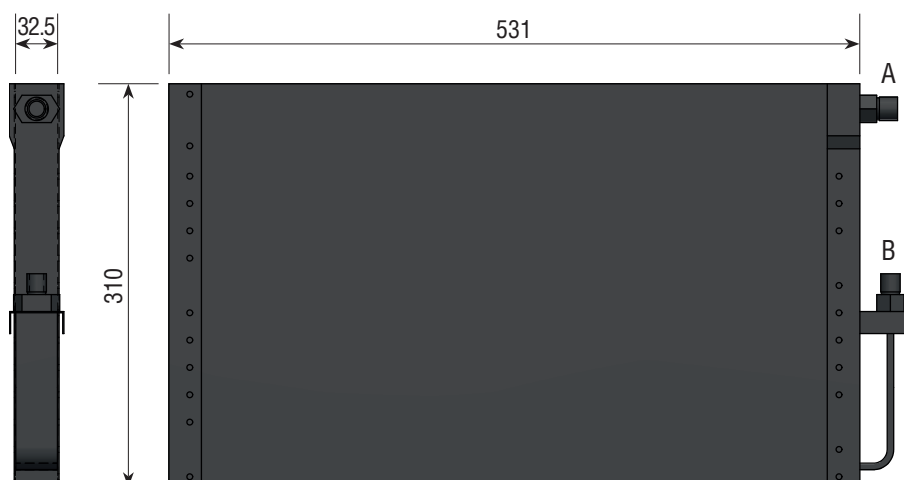

**Serpentine Condenser
Condensatore a serpentina**

Part. Codice	kcal/h	Fin Pitch Passo alette
B01200004	7000	2.1 mm

A - 3/4"-16 UNF / 2A O-Ring

B - 5/8"-18 UNF / 2A O-Ring

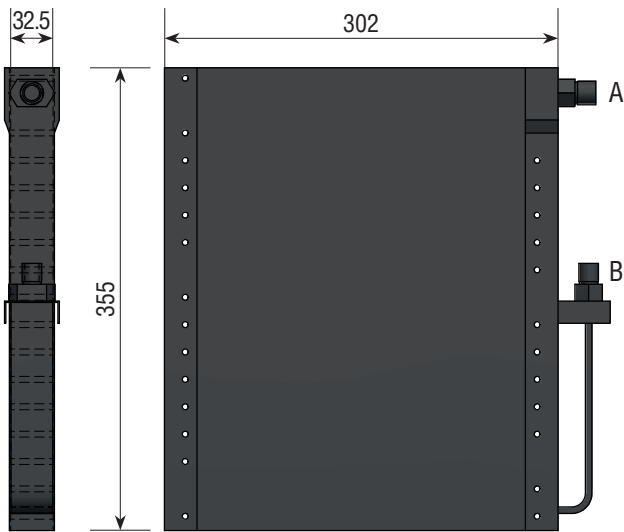

Serpentine Condenser Condensatore a serpentina

Part. Codice	kcal/h	Fin Pitch Passo alette
B01200011	4500	2.1 mm

A - 3/4"-16 UNF / 2A O-Ring
B - 5/8"-18 UNF / 2A O-Ring

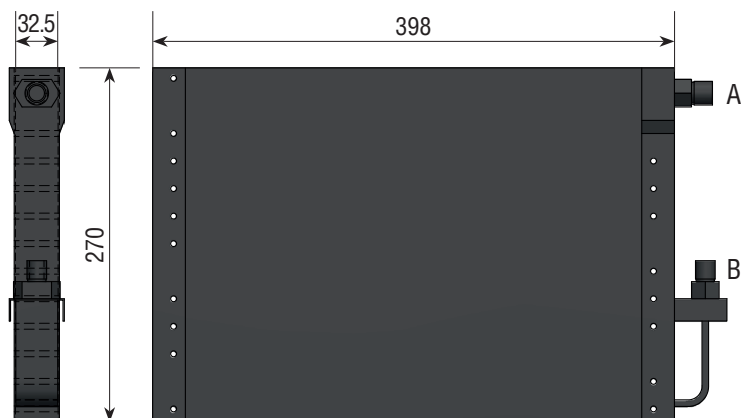

Serpentine Condenser Condensatore a serpentina

Part. Codice	kcal/h	Fin Pitch Passo alette
B01200012	5500	2.1 mm

A - 3/4"-16 UNF / 2A O-Ring
B - 5/8"-18 UNF / 2A O-Ring



Serpentine Condenser Condensatore a serpentina

Part. Codice	kcal/h	Fin Pitch Passo alette
B01200013	6000	2.1 mm

A - 3/4"-16 UNF / 2A O-Ring
B - 5/8"-18 UNF / 2A O-Ring



**Serpentine Condenser
Condensatore a serpentina**

Part. Codice	kcal/h	Fin Pitch Passo alette
B01200005	7500	2.1 mm

A - 3/4"-16 UNF / 2A O-Ring

B - 5/8"-18 UNF / 2A O-Ring

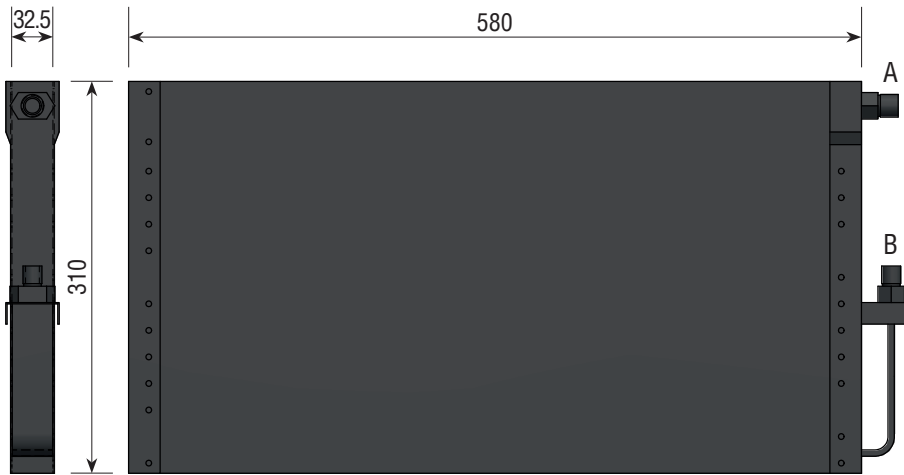

**Serpentine Condenser
Condensatore a serpentina**

Part. Codice	kcal/h	Fin Pitch Passo alette
B01200006	8500	2.1 mm

A - 3/4"-16 UNF / 2A O-Ring

B - 5/8"-18 UNF / 2A O-Ring



**Serpentine Condenser
Condensatore a serpentina**

Part. Codice	kcal/h	Fin Pitch Passo alette
B01200007	9000	2.1 mm

A - 3/4"-16 UNF / 2A O-Ring

B - 5/8"-18 UNF / 2A O-Ring

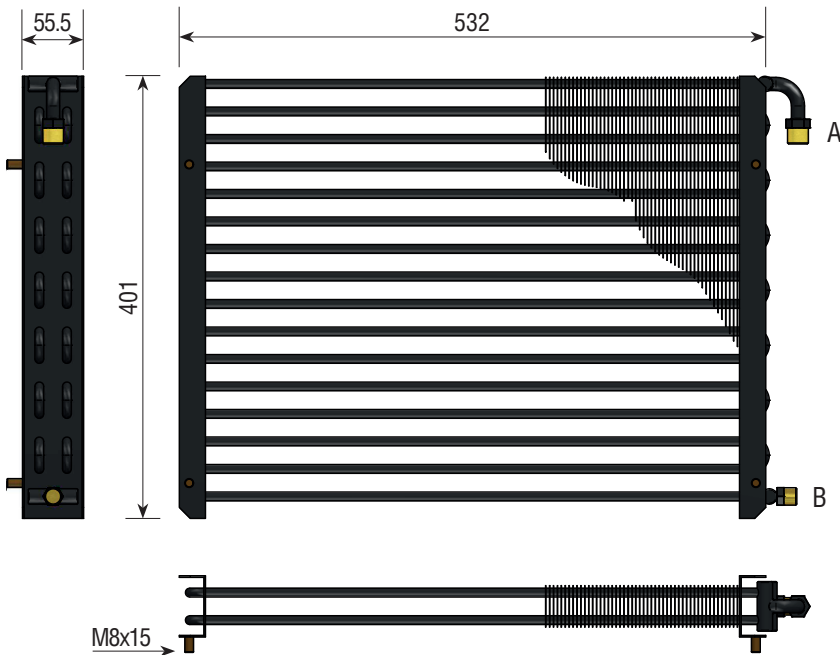

Tube and Fin Condenser Condensatore tubi e alette

Part. Codice	kcal/h	Fin Pitch Passo alette
B01200030	6800	3.25 mm

A - 3/4"-16 UNF / 2A O-Ring

B - 5/8"-18 UNF / 2A O-Ring

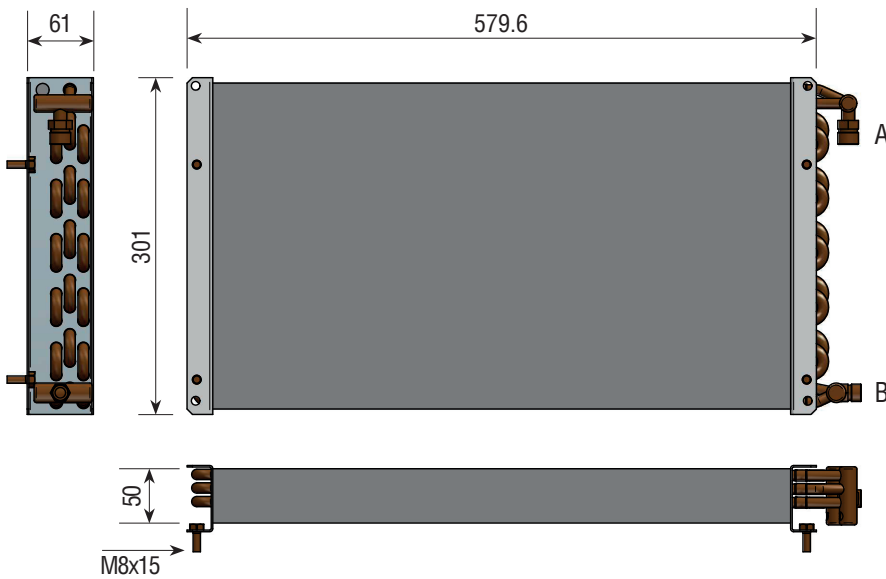

Tube and Fin Condenser Condensatore tubi e alette

Part. Codice	kcal/h	Fin Pitch Passo alette
B01200044	7500	3.25 mm

A - 3/4"-16 UNF / 2A O-Ring

B - 5/8"-18 UNF / 2A O-Ring

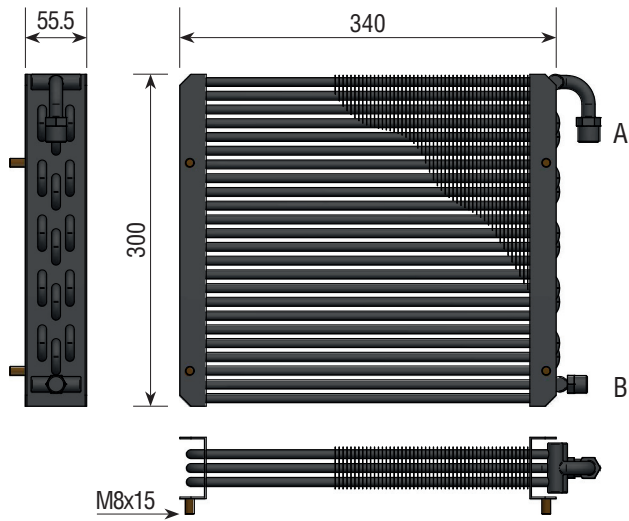

**Tube and Fin Condenser
Condensatore tubi e alette**

Part. Codice	kcal/h	Fin Pitch Passo alette
B01200045	3000	3.25 mm

A - 3/4"-16 UNF / 2A O-Ring

B - 5/8"-18 UNF / 2A O-Ring

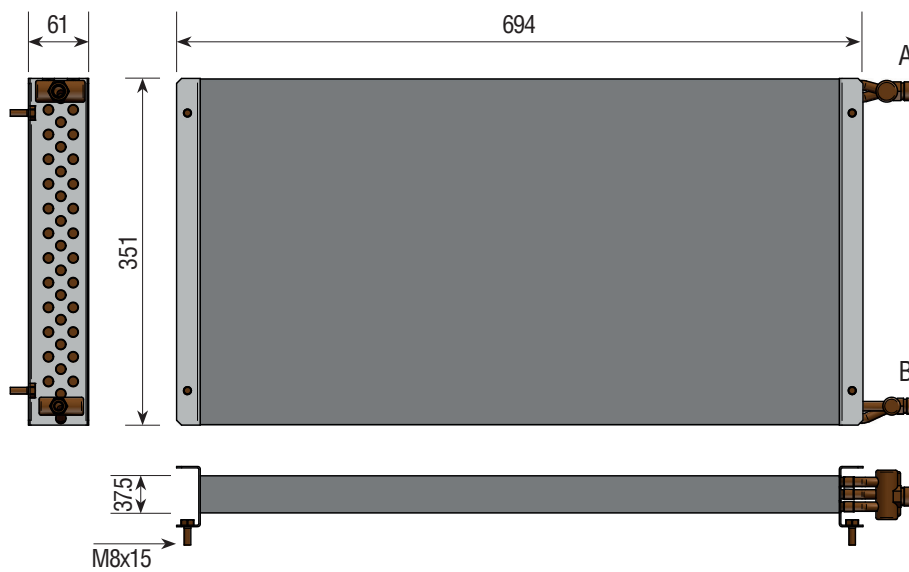

**Tube and Fin Condenser
Condensatore tubi e alette**

Part. Codice	kcal/h	Fin Pitch Passo alette
B01200056	9100	3.25 mm

A - 3/4"-16 UNF / 2A O-Ring

B - 5/8"-18 UNF / 2A O-Ring

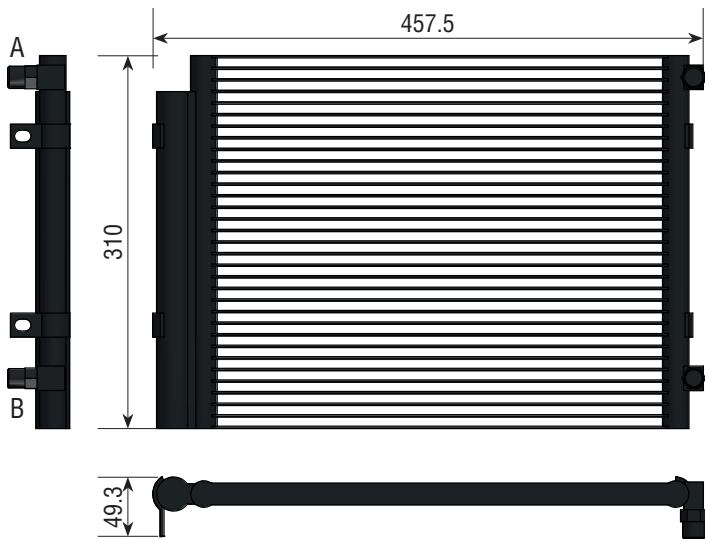

Parallel flow condenser with receiver dryer
Condensatore a flusso parallelo con filtro disidratatore

Part. Codice	kcal/h	Fin Pitch Passo alette
B01200038	6000	-

A - 3/4"-16 UNF / 2A O-Ring

B - 5/8"-18 UNF / 2A O-Ring



Parallel flow condenser
Condensatore a flusso parallelo

Part. Codice	kcal/h	Fin Pitch Passo alette
B012000086	7000	-

A - 3/4"-16 UNF / 2A O-Ring

B - 5/8"-18 UNF / 2A O-Ring

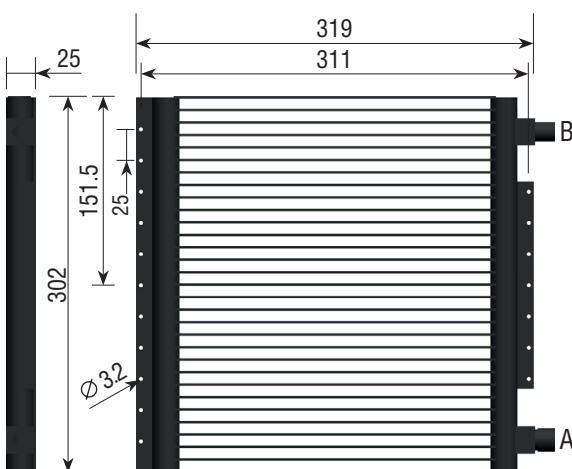

Parallel flow condenser
Condensatore a flusso parallelo

Part. Codice	kcal/h	Fin Pitch Passo alette
B012000088	4200	-

A - 3/4"-16 UNF / 2A O-Ring

B - 5/8"-18 UNF / 2A O-Ring

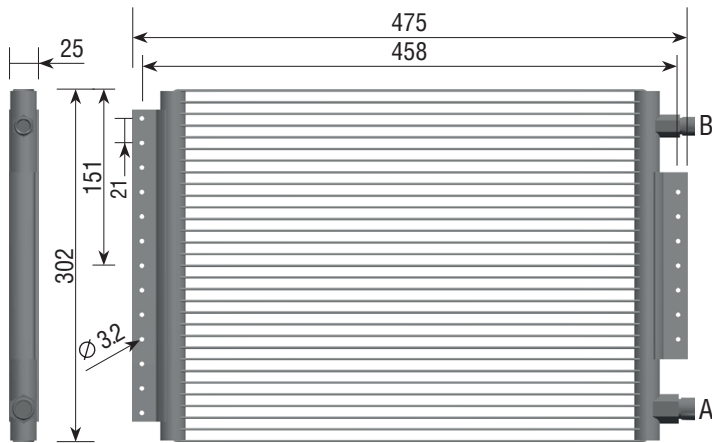

Parallel flow condenser
Condensatore a flusso parallelo

Part. Codice	kcal/h	Fin Pitch Passo alette
B012000097	6500	-

A - 3/4"-16 UNF / 2A O-Ring

B - 5/8"-18 UNF / 2A O-Ring

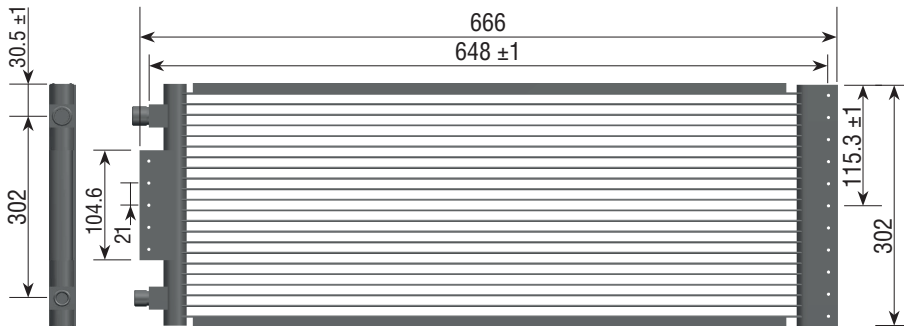

Parallel flow condenser
Condensatore a flusso parallelo

Part. Codice	kcal/h	Fin Pitch Passo alette
B012000099	6000	-

A - 3/4"-16 UNF / 2A O-Ring

B - 5/8"-18 UNF / 2A O-Ring

